

MultiController E 0-100% 24V and 230V

Manual Output Controller 0-100%, 4 Step or ON/OFF.
Scheduler and Modbus Interface

Software Version 2.6



Content

Description	1
1 Mounting	2
Terminal Connections 24V Version	2
Terminal Connections 230V Version	3
2 Functions	4
2.1 User Interface	4
2.3 Quick Set-up	5
2.4 Menu Structure	6
2.5 Main Menu and Submenus	6
2.6 System Information (A-Menu)	6
2.7 Scheduler Menu (B-Menu)	7
2.8 User Menu (C-Menu)	7
2.9 Display Menu (D-Menu)	8
2.10 Service Menu (E-Menu)	9
3 Setpoint Overview	11
4 Technical Data	12
5 Applied Standards	12

Description

MultiController E 0-100% for adjustment of output signal (0-10V) from 0 to 100%, 4-steps or ON/OFF.

The integrated scheduler function allows for individual adjustment of the output signal with up to 10 shifts per day. The scheduler/clock has an integrated battery back-up. RS-485 interface with MODBUS® protocol facilitates easy connection to network systems.

Set-up is easily performed using the built-in quick guide. MultiController E 0-100% also features a micro-SD card reader for software updates and copying of settings. Micro-SD card reader requires micro-SD cards with LS Control Firmware with the capacity of max 2Gb.

1 Mounting

MultiController E must be mounted according to the general applicable installation rules in the 'Low Voltage Directive'. The unit is to be carefully fixed on a plane and stable surface with screws in the 2 oval holes. The unit may not be fixed on moving or vibrating surfaces. Avoid that unit get exposed to high temperature and direct sunlight.

Ensure that the unit is not disturbed by electromagnetic interference from e.g. long connection cables.

Terminal Connections 24V Version

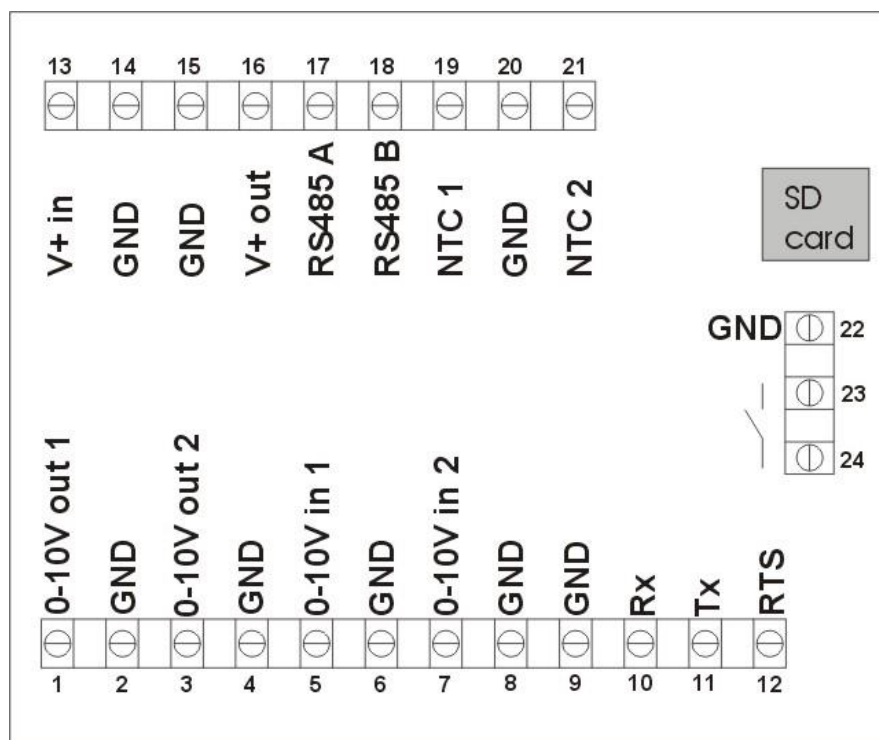

Terminal No.	Description	Comment
1 and 2 (Vout1)	0-10V output 1	Load max 10mA
3 and 4 (Vout2)	0-10V output 2	Load max 10mA
5	Not in use	
7 and 8	0-10V input (for external setpoint)	7k Ohm input impedance
13 and 14	Connection of power supply	15-30VDC or 24VAC
15 and 16	Power supply of auxiliary outlet	As terminals 13 and 14
15, 17 and 18	RS 485 Modbus	
2,4,6,8,9,14,15,20,22	0V / GND	
19	Not in use	
20 and 21	Tacho, PIR or alarm input	
23 and 24	Voltage free contact. Function depending on set-up	24VDC NO, 3A AC1

Terminal Connections 230V Version

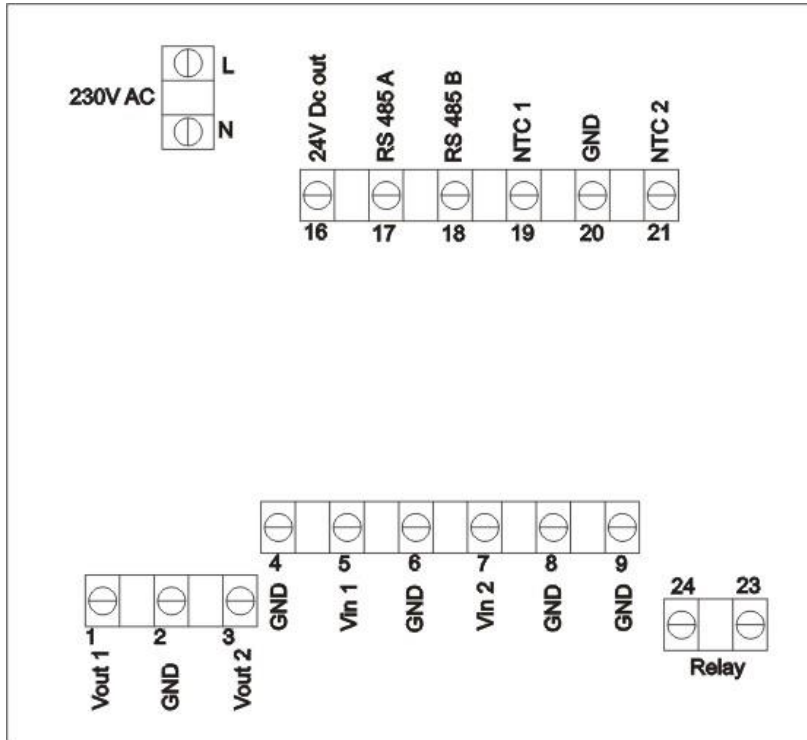



Terminal No.	Description	Comment
L and N	Connection of power supply	230V AC $\pm 10\%$
1 and 2 (Vout1)	0-10V output 1	Load max 10mA
3 and 4 (Vout2)	0-10V output 2	Load max 10mA
5	Not in use	
7 and 8	0-10V input (for external setpoint)	7k Ohm input impedance
16 and 9	24V power output	+24V DC max. 100mA
17 and 18	RS 485 Modbus	
19	Not in use	
2,4,6,8,9,20	0V / GND	
20 and 21	Tacho, PIR or alarm input	
23 and 24	Voltage free contact. Function depending on set-up.	5A-AC1, 250VAC

2 Functions

2.1 User Interface



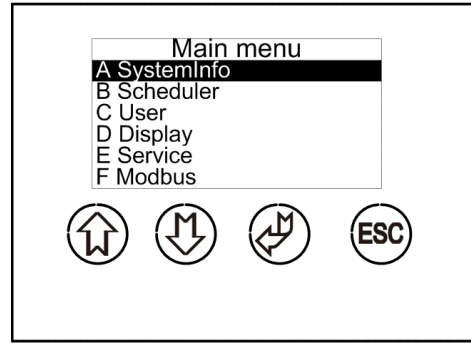

The display is operated by push-buttons.

The general function of each button is described below.

Icon	Function
	Choose / Enter
	Increase / one step up
	Decrease / on step down
ESC	Escape / cancel



Shortcuts are available in the main window. They are indicated by an icon above each button

Icon	Function
	ON/OFF
	Increase adjusted level / one step up
	Decrease adjusted level / one step down
	Go to menu

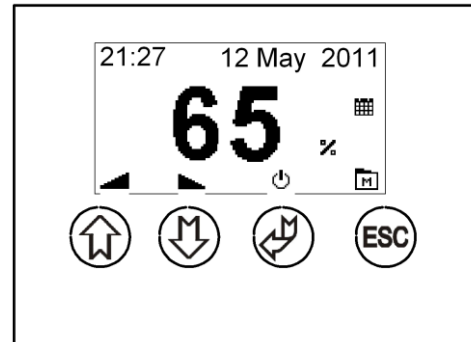

2.2 Main Window

In the main window the current output level and icons of enabled functions (scheduler and Modbus) are displayed. The icons at the bottom of the display indicates function of the buttons and if the functions 'prolonged operation' and/or 'PIR' are enabled.

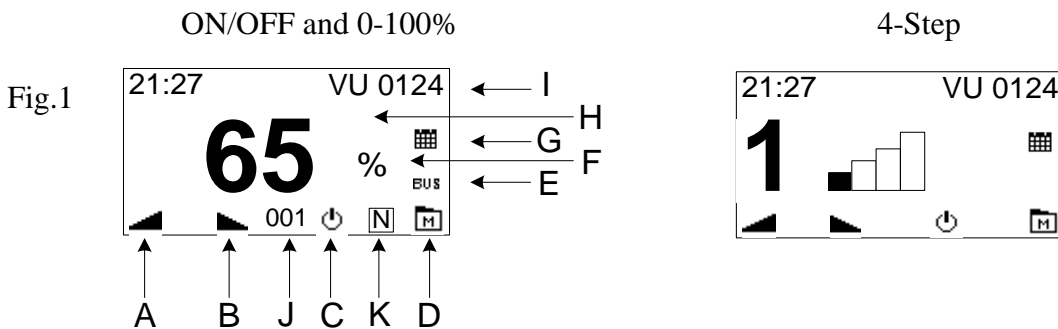

- A) By pressing "arrow up" the level of output signal is increased / or stepped up by one.
- B) By pressing "arrow down" the level of output signal is decreased / or stepped down by one.
- C) By pressing "ON/OFF" output signal shifts between turned on and turned off.
- D) By pressing "menu" The display changes to main menu.
- E) Icon indicating that Modbus communication is enabled.
- F) Icon showing that the output signal is adjusted in percentage / figure step 1 to 4
- G) Icon indicating if scheduler function is enabled.
- H) Level of the current output signal.
- I) Display of time and, if applicable, plant name /alarm
- J) Display of minutes for prolonged operation, if enabled.
- K) Icon indicating that PIR (motion sensor) operation is enabled.

2.3 Quick Set-up

When the MultiController is first connected to supply it must be chosen how it should function. First language is chosen and then the wanted quick setting (01-06).

Operating parameters are set for a standard setting. New quick setting can be performed by returning to factory setting (D4) and start over. Operating parameters can be adjusted through the menus in the MultiController.

Set-up	Description
01 ON/OFF	Shift between 2 levels (low/high). Both voltage levels are adjustable, e.g. 0.0/10V, 3.5/8.0V etc. Pres 'Enter' to shift between the levels or let the build-in scheduler determine the shifts. Relay output is closed at "ON".
02 0-100%	Stepless adjustment by pressing "Arrow Up" and "Arrow Down". The integrated scheduler function can be set to shift amongst 3 different operating levels; Stop, Normal Setpoint or Alternative Setpoint. Relay output is closed when voltage level is higher than selected value (factory setting is 0.1V, i.e. the relay operates as an operation relay).
03 0-100% PIR	As set-up 02, but instead of using the scheduler function a PIR (motion) sensor is connected to shift between Normal and Alternative Setpoint*. When choosing PIR in set-up, the possibility of using the scheduler function is deactivated.
04 0-100% Tacho	As set-up 02. And monitoring EC-motors Tacho-signal (rotation guard). Displaying alarm text if tacho signal becomes absent.
05 4-Step	For controlling in 4 predefined fixed steps. (Each step is user defined).
06 2-Step PIR	Shifts between 2 operating levels* via a connected PIR (motion) sensor.

*Or shift between stop and an operation level.

**Set-up 01 (ON/OFF), 02 (0-100%),
03 (0-100% PIR), 05 (4-step) and
06 (2-step PIR):**

Set-up 04 (0-100% Tacho)

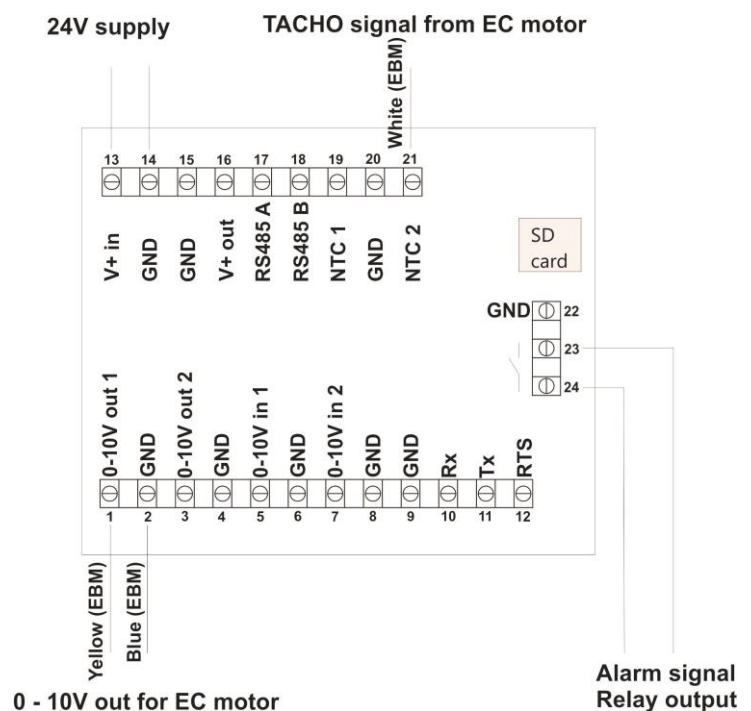
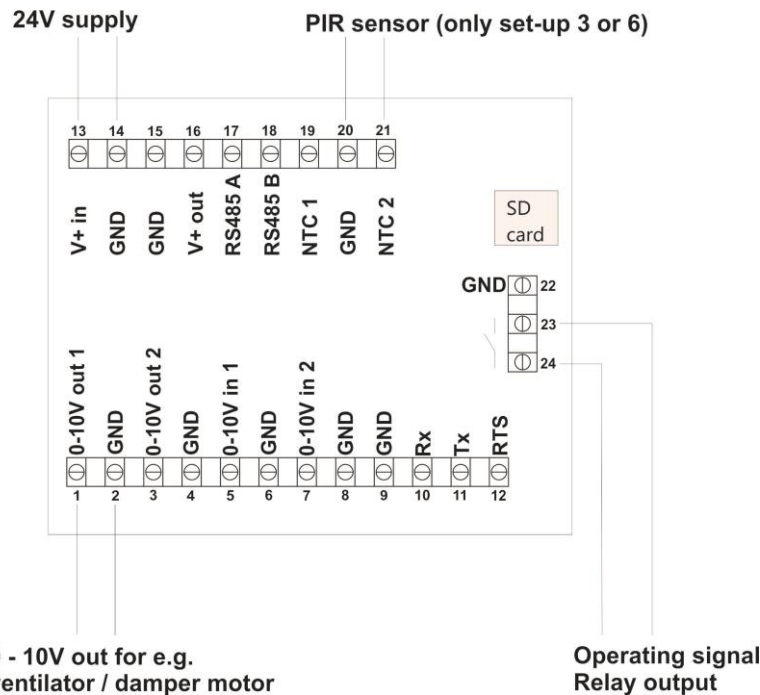

2.4 Menu Structure

The MultiController E 0-100% is operated by 4 push buttons. The function of the individual button is indicated on the button and the menus consist of a main menu with submenus. Configuration and adjustment of the parameters is performed in the submenus. Automatic time out from a menu if no buttons have been activated for 2 minutes.

Example of menu operation

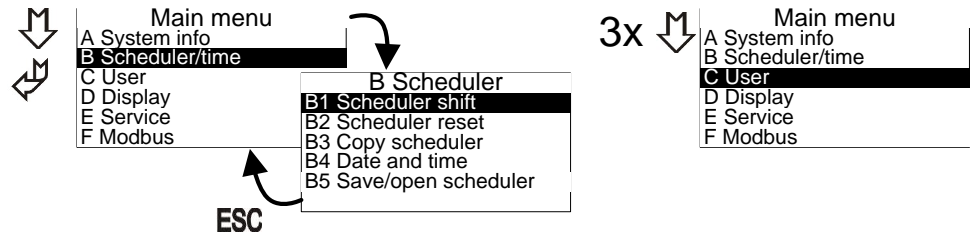

Various pop-up boxes for editing parameters are available.

Time
↓
18 : 45

Value is adjusted using arrow up and arrow down. Cursor is moved to next position by pressing "Enter". When finished adjusting the value is saved by pressing "Enter". Pressing "ESC" will cancel the adjustment by leaving the pop-up / submenu without saving.

2.5 Main Menu and Submenus

The submenus A – F are accessible from the main menu.

Main menu	
A	System info
B	Scheduler/time
C	User
D	Display
E	Service
F	Modbus

2.6 System Information (A-Menu)

Current operating data for MultiController is displayed in this menu. Data is updated every 5 seconds.

Information		Information	
01 I-ntc	: 21.4	07 VIN1	: 32 %
02 Ntc1	: 23.4	08 VIN2	: 74 %
03 Ntc2	: -13.7	09 VOUT1	: 1 %
04 VIN1C	: 2.1	10 VOUT2	: 100%
05 VIN2C	: 8.6	11 PID1	: 10
06 REL	: ON	12 PID2	: 1000

01: I-ntc	Internal temperature
02: Ntc1	Not in use
03: Ntc2	Not in use
04: VIN1C	Not in use
05: VIN2C	Not in use
06: REL	Relay position 'OFF' = switch is open, 'ON' = switch is closed, (terminal 23+24)
07: VIN1	Measured input signal on VIN1 input (terminal 5+6)
08: VIN2	Measured input signal on VIN2 input (terminal 7+8)
09: VOUT1	Output signal on VOUT1 (terminal 1+2)
10: VOUT2	Output signal on VOUT2 (terminal 3+4)
11: PID1	Not in use
12: PID2	Not in use

2.7 Scheduler Menu (B-Menu)

The integrated scheduler function is a week scheduler with possibility of 10 shifts per day. The scheduler function is enabled / disabled in the user menu (C3). If scheduler is activated, an icon appears in the main window.

B Scheduler	
B1	Scheduler shift
B2	Scheduler reset
B3	Copy scheduler
B4	Date and time
B5	Save/open scheduler

B1:

Scheduler is programmed in menu B:

<table border="1"> <thead> <tr> <th colspan="2">Main menu</th> </tr> </thead> <tbody> <tr> <td>A</td> <td>systeminfo</td> </tr> <tr> <td>B</td> <td>Scheduler/time</td> </tr> <tr> <td>C</td> <td>User</td> </tr> <tr> <td>D</td> <td>Display</td> </tr> <tr> <td>E</td> <td>Service</td> </tr> <tr> <td>F</td> <td>Modbus</td> </tr> </tbody> </table>	Main menu		A	systeminfo	B	Scheduler/time	C	User	D	Display	E	Service	F	Modbus	<table border="1"> <thead> <tr> <th colspan="2">B Scheduler</th> </tr> </thead> <tbody> <tr> <td>B1</td> <td>Scheduler shift</td> </tr> <tr> <td>B2</td> <td>Scheduler reset</td> </tr> <tr> <td>B3</td> <td>Copy scheduler</td> </tr> <tr> <td>B4</td> <td>Date and time</td> </tr> <tr> <td>B5</td> <td>Save/open scheduler</td> </tr> </tbody> </table>	B Scheduler		B1	Scheduler shift	B2	Scheduler reset	B3	Copy scheduler	B4	Date and time	B5	Save/open scheduler	<table border="1"> <thead> <tr> <th colspan="2">01 Monday</th> </tr> </thead> <tbody> <tr> <td>02</td> <td>Tuesday</td> </tr> <tr> <td>03</td> <td>Wednesday</td> </tr> <tr> <td>04</td> <td>Thursday</td> </tr> <tr> <td>05</td> <td>Friday</td> </tr> <tr> <td>06</td> <td>Saturday</td> </tr> <tr> <td>07</td> <td>Sunday</td> </tr> </tbody> </table>	01 Monday		02	Tuesday	03	Wednesday	04	Thursday	05	Friday	06	Saturday	07	Sunday	<table border="1"> <thead> <tr> <th colspan="2">Monday</th> </tr> </thead> <tbody> <tr> <td>01</td> <td>00 : 00 - - - -</td> </tr> <tr> <td>02</td> <td>00 : 00 - - - -</td> </tr> <tr> <td>03</td> <td>00 : 00 - - - -</td> </tr> <tr> <td>04</td> <td>00 : 00 - - - -</td> </tr> <tr> <td>05</td> <td>00 : 00 - - - -</td> </tr> <tr> <td>06</td> <td>00 : 00 - - - -</td> </tr> <tr> <td>07</td> <td>00 : 00 - - - -</td> </tr> </tbody> </table>	Monday		01	00 : 00 - - - -	02	00 : 00 - - - -	03	00 : 00 - - - -	04	00 : 00 - - - -	05	00 : 00 - - - -	06	00 : 00 - - - -	07	00 : 00 - - - -
Main menu																																																											
A	systeminfo																																																										
B	Scheduler/time																																																										
C	User																																																										
D	Display																																																										
E	Service																																																										
F	Modbus																																																										
B Scheduler																																																											
B1	Scheduler shift																																																										
B2	Scheduler reset																																																										
B3	Copy scheduler																																																										
B4	Date and time																																																										
B5	Save/open scheduler																																																										
01 Monday																																																											
02	Tuesday																																																										
03	Wednesday																																																										
04	Thursday																																																										
05	Friday																																																										
06	Saturday																																																										
07	Sunday																																																										
Monday																																																											
01	00 : 00 - - - -																																																										
02	00 : 00 - - - -																																																										
03	00 : 00 - - - -																																																										
04	00 : 00 - - - -																																																										
05	00 : 00 - - - -																																																										
06	00 : 00 - - - -																																																										
07	00 : 00 - - - -																																																										

E.g.

Monday 01 00 : 00 - - - -	Monday 01 00 : 00 - - - -	Monday 01 00 : 00 - - - -	Monday 00 : 00 25%	Monday 00 : 00 25%	Monday 00 : 00 2
------------------------------	------------------------------	------------------------------	-----------------------	-----------------------	---------------------

Set time for the requested shift and press “enter” ↵ Then set required level (OFF/ON, 0-100%, Step 1-4)

Repeat above steps for required numbers of days and shifts per day.

NB! A shift is only active if required level is different from ----

Note it is possible to change the setpoint manually in the main window (unless locked by security level). However at next scheduler shift the controller will return to the preset setpoint value from scheduler.

B2: Scheduler Reset.

This menu point resets the scheduler. **Note:** All settings in scheduler is deleted!

B3: Scheduler Copy.

Copy all scheduler setting from one weekday to another. Previous settings are overwritten by this copying function.

B4: Date and Time.

The date, weekday and time for the MultiController is set in this menu.

Clock is a 24-hour clock. Optional choice of automatic shift between summer and normal time.

MultiController E has integrated battery back-up for the clock ensuring that short power cuts do not affect the clock.

In case of longer power cuts (> 72 hours) the clock must be reset.

B5: Save / Retrieve Scheduler.

It is possible to copy all scheduler settings by using the “Save/Open Scheduler” function. Insert a MicroSD-card (according to specifications) in the Multicontroller and press save. Then move the SD-card to the next MultiController and retrieve the settings via menu B5 and press 'Open'.

2.8 User Menu (C-Menu)

The user menu consists of the most frequently used configuration controls.

C1: Level / setpoint is adjusted in this menu point. (Has no function in 4-step / 2-step PIR setting)

Level / setpoint may be altered from main window (arrow up/down). However, this is only active until next scheduled event.

C2: Enabling and disabling of integrated scheduler.

C3: Boost Function.

From OFF position it is possible to start with a boost at the 0-10V output (e.g. to boost start a large motor). The boost level is set in menu point **E3**. To disable the boost function, set the time to 0 seconds.

C4: Security level is set in this function.

0 = Only service menu is password protected (password: **5550**)

1= All menus are password protected

2= All buttons except 'Enter' (On/off function) are password protected.

3= All buttons are password protected.

C5: Prolonged Operation (Number of minutes).

Function is activated by pressing the 'Enter' button for 3 seconds, then choose "ON" using the arrow buttons. At end of prolonged operation time the MultiController stops (OFF), it will start again when pressing 'Enter' (on/off), or at next scheduled shift. Prolonged operation is indicated by icon in display (see "J" on fig. 1 page 4).

C6: Setpoint Source.

Set if setpoint (level) is set via the MultiController or by external control signal from input Vin2.

If "External" is selected the signal must be defined in **E25-E28** and **E42** set to "Volt".

C8: Alarm. (Only active if E42=ALARM1 / ALARM2)

If set to 0 sec. the alarm is deactivated. If set to 2-60 sec. the alarm is activated. The time indicates how long the alarm input (NTC2+GND) must be open before alarm occurs. ALARM= (terminal 23-24) opens and is indicated in display with "Alarm Din". ALARM2=Alarm is indicated in display with "Alarm Din", but relay is not affected.

NOTE. If ALARM1 is activated the normal operation relay function is not operational.

C9: Optional Plant Text is activated or deactivated. Text is entered in **E44**.

C10: Operation Hour Counter

Enter the number of moths after which "service text" appears in display. Text is displayed 15 seconds each minute until counter is reset. Text is entered in **E45**.

Reset of counter: When, "Service text" is NOT visible in the display, press 'ESC' for approx. 3 sec. Then press 'enter' to accept the reset.

2.9 Display Menu (D-Menu)

The display menu contains the general display settings.

D1: Information on software version and model.

D2: Language. Choose display language amongst Danish, English, Swedish or German.

D3: Contrast in display. Adjust using the arrow buttons.

D4: Factory reset.

Hence factory reset affects vital configuration, reset has an extra approval build-in before factory reset is performed. Note scheduler is also completely reset. After reset the MultiController restarts showing quick-setup for selecting functionality of MultiController.

D5: Save / Retrieve Setpoints.

Save setting to MicroSD Card / Open (retrieve) setting from MicroSD Card (max 2GB with LS Control firmware).

D6 (Only available if MultiController is purchased as model Regulate). Choose if MultiController should operate as a controller or manual (0-100%) regulator. If controlling (model Regulate) is chosen please refer to manual for MultiControllerE Regulate, which may be downloaded from www.lscontrol.dk.

2.10 Service Menu (E-Menu)

In the service menu the advanced settings of the controller are found. Hence these settings are vital and erroneous adjustments may ruin the function of the controller this menu is by default password protected.

Password is 5550

Below Settings may be altered in the service menu:

E1: Model Choice (functionality choice).

Set if controller output signal is to function as ON/OFF, Stepless Percentage (0-100%), or 4-step.

E2: Minimum Output Voltage.

If the connected equipment is unable to regulate from 0V, the minimum voltage of the output signal (Vout1) may be adjusted in this menu point.

E3: Maximum Output Voltage.

If the connected equipment is unable to regulate up to 10V, the maximum voltage of the output signal (Vout1) may be adjusted in this menu point. **Note;** This also set the boost level (100 %).

E4: Adjustment of Start Level.

The manual start level may be set at 3 different start values.

- 1) Minimum level.
- 2) Maximum level.
- 3) Latest level of controller when turned off.

Note this functionality is only available when MultiController model choice (**E1**) is set to percentage.

Boost function (menu point **C3**) overrules start level adjustment.

E5: Inverted output.

Option for inverting the output signal. E.g. 100% = 0V out / 1%=9,9V out.

E6: Relay Shifting Point.

Setting of output voltage (Vout1) at which relay shifts from inactive to active. If E6=0, then relay shifts when regulator is activated. **If alarm function is activated (C8) and (E42= ALARM1) this menu point is obsolete.**

E25-E28 These menu points set up control of MultiController setpoints via an external control signal. In E25/E26 the voltage range is defined. In E27/E28 the corresponding min. and max. voltage signals (in %) are defined.

E25: Minimum voltage supplied by source of external control signal (voltage source) on Vin2.

E26: Maximum voltage supplied by source of external control signal (voltage source) on Vin2.

E27: Signal value at minimum.

Enter the corresponding minimum value in % (e.g. 0V=0%) of the voltage source at minimum (**E25**).

E28: Signal value at maximum.

Enter the corresponding maximum value in % (e.g. 10.0V=100%) of the voltage source at maximum (**E26**).

E40: Vout2 (output 2)

E40=0, Vout2 is firm 10V DC. E40=1 Not in use. E40=2, output is an offset of output 1 (Vout1). See **E49**. E40=3, output is 10V when regulator is 'on' and 0V when 'off'. E40=4, output is 10V when regulator 1 is higher than value in E2 (minimum output Reg1), if regulator 1 = E2, output is 0V.

E42: Selection of Sensor Input

NTC22K= Not in use. **Volt**= 0-10V signal on terminal 7-8 (0-10V signal is defined in E25-E28).

Alarm1= 20-21(NTC2) used as alarm input (open signal=alarm text + relay) **Tacho**= terminal 20-21

PIR1= terminal 20-21(open signal = no movement in room). **NTC10K**= not in use. **PIR2** (Shift between NORM/OFF operation) = terminal 20-21. **Alarm2**= 20-21 (NTC2) used as alarm input (open signal=alarm text).

E44: User defined text; Name.

Optional feature of entering a plant name or similar. E.g. "Plant 4" (max. 12 characters. The text is enabled in **C9**).

E45: User defined text; Operation Hour Counter.

Optional feature of entering a service text or similar. E.g. "It is time for service" (max 6 lines of 12 characters. The text is enabled in **C10**).

E46: Alarmlevel Min. (Alarm is activated in **C8**)

If **E42**= **TACHO**: Lower limit of tacho signal. *Adjustment*: If tacho alarm occurs when motor is running minimum rpm, value must be increased.

If **E42** = **Alarm1** / **Alarm2**: If alarm occurs when input is closed via an "open collector" value must be increase. (In input is closed via a relay contact, adjustment is not necessary.

E47: Alarm level Max: (Alarm is activated in **C8**). Upper limit of tacho signal. *Adjustment*: If tacho alarm occurs when motor is running maximum rpm, value must be increased.

E48: PIR Time. Prolonged operation time for PIR input in seconds.

E49: Offset of Vout2 in relation to Vout1. (Only if **E40**=2). Formula: $Vout2=Vout1 \times (E49/100)$

E52: Time Delay (in seconds) before output signal is released at start. Output signal (Vout1) is maintained at 0V in the set time. Relay shifts with no delay.

E55: Level for step 1 (in percentage). Only used when set-up as 4-step regulator.

E56: Level for step 2 (in percentage). Only used when set-up as 4-step regulator.

E57: Level for step 3 (in percentage). Only used when set-up as 4-step regulator.

E58: Level for step 4 (in percentage). Only used when set-up as 4-step regulator.

2.11 Modbus menu (F-menu)

MultiController E 0-100% may be configure as Modbus slave. The interface is serial RS-485 and the Modbus unit communicates according to the RTU standard with up to 19200 Baud. Download the Modbus parameter list from www.lscontrol.dk

Note: The data points in the menu may be set from a Modbus-master. Except F4 as it works as blocking for Modbus altering of configuration /setting. Following Modbus setting may be altered from the Modbus menu:

F1: Address: Slave address is entered here.

F2: Baudrate may be set to OFF, 9600 or 19200. Modbus is only activated when baudrate is set to 9600 or 19200.

F3: Parity: May be set to EVEN, ODD, NONE.

F4: Allow writing from Modbus. Set configuration at 1, if configuration is to be altered from the Modbus master.

Note: Cannot be altered by Modbus, must be altered manually in MultiController.

3 Setpoint Overview

Name	Factory Setting	Min	Max	Unit
C1 Level	50	0	100	%
C2 SchedulerOnOff	OFF	OFF	ON	Activated/deactivated
C3 BoostTime (0-250sec)	5	0	250	Seconds
C4 UserRights (Security Level)	0	0	3	
C5 Prolonged Operation	10	1	240	Minutes
C6 Setpoint Source	Internal	Internal	External	
C8 Alarm Function	0	0	60	Seconds.
C9 Optional Text	OFF	OFF	ON	
C10 Operation Hour Counter	0	0	12	months
E1 Model (ON/OFF,Percentage %, Step)	Depending of Setting			
E2 OutputMin (0-5V)	0	0	50	Volt 50 = 5.0V
E3 OutputMax (5-10V)	100	50	100	Volt 50 = 5.0V
E4 OutputStart (Min,Max,Last)	Last	Min	Max	
E5 Inverter output	OFF	OFF	ON	
E6 Relay Shifting Point	0.1	0.0 V	10.0 V	Volt
E26 Max Input2	10,0	0,0	10,0	Volt
E27 Sensor 2 value min	0	0	100	%
E28 Sensor 2 value max	0	0	100	%
E40 Vout2 (0=10V 1= not in use 2=Offset of Vout1)	0	0	2	
E42 TempSensor2 selection (NTC22 = NTC2 Volt = Vin2, Alarm1 = NTC2, Tacho = NTC2, PIR1= NTC2, NTC10K = not in use, PIR2 = NTC2) Alarm2 = NTC2	NTC22			
E44 User Text Name				
E45 User Text Counter				
E46 Alarm Level Min	10	0	50	
E47 Alarm Level Max	60	50	100	
E48 PIR Time	10	1	36000	Seconds
E49 Out 2 Offset	100	0	200	%
E52 Time before Regulation	0	0	240	Seconds
E55 Step Level 1 (in percentage)	25	0	100	%
E56 Step Level 2 (in percentage)	50	0	100	%
E57 Step Level 3 (in percentage)	75	0	100	%
E58 Step Level 4 (in percentage)	100	0	100	%
F1 ModbusAddress (1-247)	50	1	247	Address
F2 Modbus baudrate (0=Off 1=9600 2=19200)	0	0	2	Speed
F3 Modbus Parity1=EVEN 2=ODD 3=NONE)	1	1	3	Data
F4 ModbusAllowWrite	OFF	OFF	ON	OFF/ON

4 Technical Data

	24V Version	230V Version
Supply Voltage	15-30VDC or 24VAC +/-15%	230V AC ±10%
Mains	Max 1A	13A
Power Consumption	Max. 2,4W	Max. 1W
Enclosure	IP 40	IP 40
Dimension (hxwx d)	LSBOX85: 34x87x87 mm	LSBOX85: 42x87x87 mm
	DIN rail: 45x85x120 mm	
	Panel mounting: 100x100x65 mm (hul: 91x91 mm)	
	IP 54 box: 120x122x56 mm	
Operating Temperature	0 - 60 °C	0 - 50 °C
Relay	24VDC NO, 3A AC1.	5A-AC1, 250VAC NO, 150W / 1150VA.
0-10VDC input1 (Vin1)	7k Ohm input impedance	
0-10VDC input2 (Vin2)	7k Ohm input impedance	
0-10VDC output1 (Vout1)	0-10,0V DC Max 10mA	
0-10VDC output2 (Vout2)	0-10,0V DC Max 10mA	
RS-485	Channel A and B	
SD Card	MicroSD, max 2GB with LS Control Firmware	
Jumper	120 Ohms termination RS-485	

5 Applied Standards

EN 61000-6-1 and EN 61000-6-3 Electromagnetic Compatibility (EMC)

EN-60335-1 The Low Voltage Directive

This product complies with the RoHS directive, Directive 2011/65/EU.

Drawing: 950-206725 MultiControllerE-0-100_ES874_26_UK

Date: 29/10-2018

Rev.: 2.8

Software version: Program 2.6

Written by: UP

Manufacture: LS Control A/S Industrivej 12, DK 4160 Herlufmagle.

www.lscontrol.dk - ☎. +45 5550 5550



LSCONTROL