

MultiController E Regulate 24V og 230V

Multi-function Controller with Display, Scheduler Function
and Modbus interface

Software version 2.6



Content:

1 Mounting.....	2
1.1 Terminal Connections 24V Version	2
1.1 Terminal Connections 230V Version	3
2 Functions.....	4
2.1 User Interface.....	4
2.2 Main Window	4
2.3 Quick Guide for Setting-Up.....	5
2.4 General Menu Structure.....	8
2.5 Main Menu and Submenus	8
2.6 System Information (A-menu).....	8
2.7 Scheduler Menu (B-menu):.....	9
2.8 User Menu (C-menu)	10
2.9 Display Menu (D-menu).....	11
2.10 Service Menu (E-menu).....	11
3 Setpoint Overview	17
4 Technical Data	20
5 Applied Standards.....	20

Description

The MultiController E Regulate is a PID/XP multi-function controller with integrated display.

It is equipped with a built-in week-scheduler for automatic control of setpoints and on/off. Furthermore, it may be set to signals from different type of sensors such as pressure, flow, temperature, CO₂ and humidity.

MultiController E Regulate consist of 2 built-in regulators with 0-10VDC output and a voltage free relay-output which may be used for various purposes. Additionally, it is equipped with outdoor temperature compensation, flexible sensor adaptation and Modbus through RS485 connection.

Set-up and adjustment is easily performed using the integrated quick guide menus. In addition, software updates, import/export of scheduler and setpoints is easily performed using the built-in micro-SD card reader (supports card up to 2GB).

1 Mounting

MultiController E is to be mounted according to the general applicable installation rules in the low voltage directive. The panel is mounted on a plane and stable surface and carefully fixated with 2 screws in the 2 oval holes. The MultiController E must not be mounted on moving or vibrating surfaces.

Direct sunlight and high temperatures must be avoided. When long connection cables are used it must be ensured that the Multicontroller is not inflicted by electromagnetic interference.

1.1 Terminal Connections 24V Version

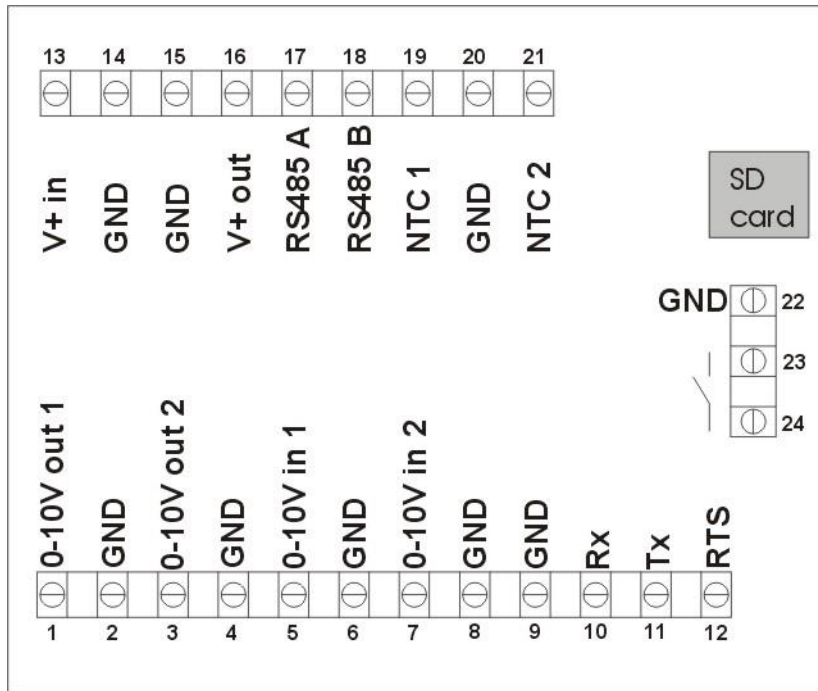

Terminal Number	Description	Comment
1 and 2 (Vout1)	0-10V output 1	Load max 10mA
3 and 4 (Vout2)	0-10V output 2	Load max 10mA
5 and 6 (Vin1)	0-10V input 1	7k ohm input impedance
7 and 8 (Vin2)	0-10V input 2	7k ohm input impedance
13 and 14	Power supply connection	15-30VDC or 24VAC
15 and 16	Power supply auxiliary outlet	As terminal 13 and 14
15,17 and 18	RS 485 Modbus	
19 and 20	Temperature sensor NTC1	10k or 22k Ohm NTC
20 and 21	Temperature sensor NTC2 or Alarm input or PIR input	10k or 22k Ohm NTC or switch
2,4,6,8,9,14,15,20,22	0V	
23 and 24	Voltage free contact. Function depending on model.	Max.24VDC, 3A AC1

1.1 Terminal Connections 230V Version

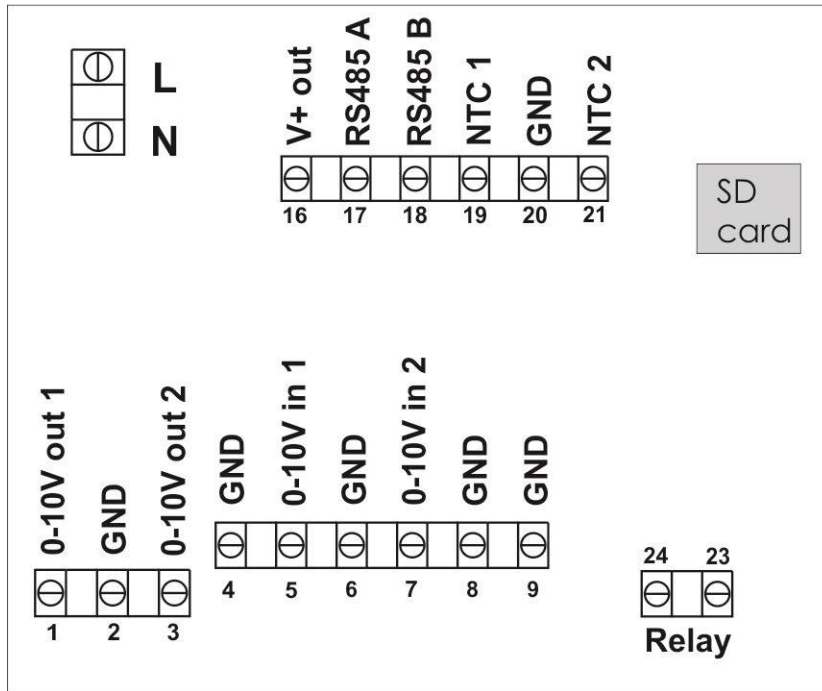



Terminal Number	Description	Comment
1 and 2 (Vout1)	0-10V output 1	Load max 10mA
3 and 4 (Vout2)	0-10V output 2	Load max 10mA
5 and 6 (Vin1)	0-10V input 1	7k ohm input impedance
7 and 8 (Vin2)	0-10V input 2	7k ohm input impedance
L and N	Power Supply Connection	230V AC $\pm 10\%$
16	24V Power Outlet	+24VDC max 100mA
17 and 18	RS 485 Modbus	
19 and 20	Temperature Sensor NTC1	10k or 22k NTC
21 and 20	Temperature Sensor NTC2 or Alarm input or PIR input	10k or 22k NTC or Switch
2,4,6,8,9,20	0V, GND	
23 and 24	Voltage free contact. Function depending on model.	Max 5A-AC1, 250VAC

2 Functions

2.1 User Interface





The display is operated by push buttons.

The general function of each button is explained below.

Button	Functionality
	Choose / Enter
	Increase / step up in menu
	Decrease / step down in menu
ESC	Escape / Cancel

Shortcuts are available in the main window display.

Shortcuts are indicated by an icon above each button.

Icon	Functionality
	Shift amongst Normal/Alternative/Stop. Press for 3 sec. to activate "prolonged operation"
	Adjust to higher setpoint / increase setpoint
	Adjust to lower setpoint / decrease setpoint
	Go to menu

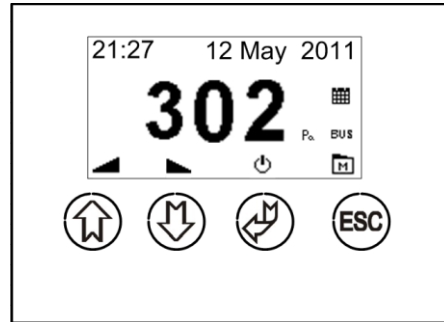
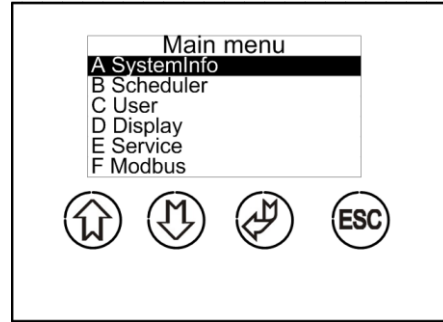

2.2 Main Window

In the main window the actual setpoint or measured value is displayed along with the status of enabled functions (e.g. Scheduler and Modbus). The icons in the base of the display screen indicate the functionality of the push buttons right below.

- A) By pressing "Arrow up" the selected setpoint is increased. Fig.1
 B) By pressing "Arrow down" the selected setpoint is lowered.
 C) By pressing "on/off" the controller will shift amongst turned on normal operation / turned on alternative operation and turned off.
 D) By pressing "menu" the display window change to main menu.
 E) Icon indicating that Modbus communication is enabled.
 F) Icon indicating current unit setting (E1)
 G) Icon indicating the scheduler function is enabled.
 H) Setpoint is indicated by "Set" just after the value number.
 I) Display of time and if applicable plant name / alarm.
 J) Display of prolonged operation time (in minutes).
 K) Display of normal setpoint (N) alternative setpoint (A) or (Pir) PIR operation (motion sensor).

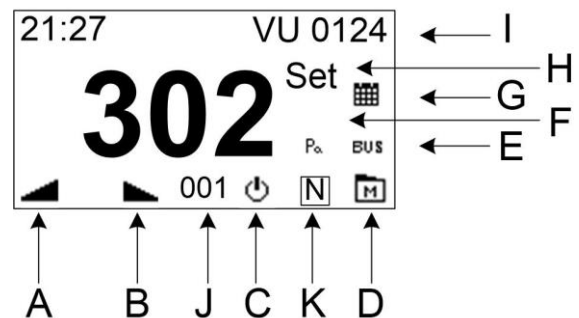

The Main Window can display both regulators in same screen (double window). Refer to menu option C7.

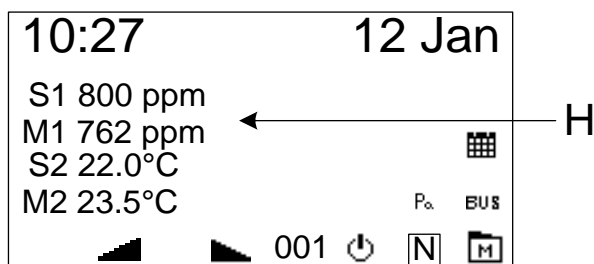

S1: Setpoint for regulator 1

M1: Measured value from sensor referring to regulator 1

S2: Setpoint for regulator 2

M2: Measured value from sensor referring to regulator 2

2.3 Quick Guide for Setting-Up

The first time the controller is connected to power, the functions of the controller must be selected. First the language of the controller must be selected, then the desired set-up (01-06).

When choosing one of the quick set-ups the operation parameters will be adjusted to a standard set-up according to the selected functionality. The quick set-up or any other set-up may be re-done by resetting the unit to factory setting (D4).

Choice of Regulator Function	Type / Output
01 Temperature	Temperature 0-10V. Used for temperature control by damper, ventilator or water valve using a 0-10V signal.
02 Temperature; 1 heating element:	Temperature 1. Used for temperature control of one (1) electrical heating element by Solid State Relay. 1 pulse output 0/10V.
03 Temperature; 2 heating elements:	Temperature 2. Used for temperature control of two (2) electrical heating elements by Solid State Relays. Heating element 1 is pulse controlled, heating element 2 is subsequently switched on. The power distribution should be: 1+1 2 pulse outputs 0/10V.
04 Temperature; 3 heating elements:	Temperature 3. Used for temperature control of three (3) electrical heating elements by Solid State Relays. Heating element 1 is pulse controlled, heating elements 2 and 3 are binary switched in. The power distribution should be: 1+1+2. 3 pulse outputs: 2 x 0/10V+ 1 x relay.
05 Constant flow	Used for maintaining a constant flow velocity in the ventilation. 0-10V output.
06 Constant pressure	Used for maintaining a constant pressure in the ventilation / room. 0-10V output.
07 Constant humidity	Used for maintaining a constant humidity level in a room. 0-10V output.
08 Constant CO ₂	Used for maintaining a constant CO ₂ level in a room. 0-10V output.
09 CO ₂ +Temp	Used for maintaining a constant CO ₂ / temperature level in a room (if either CO ₂ or temperature exceeds their maximum, the output signal increases). 0-10V output.
10 Temp + Temp	Used for maintaining a constant temperature in a room by use of wall sensor. In addition, an inflow sensor is connected to ensure a minimum inflow temperature is maintained regardless of room temperature (avoid draft problems). 0-10V output.
11 Compressor	Used for controlling a cooling compressor + condenser fan. Separate manual for this function can be downloaded from our web side.

Description of Set-Up Options:

Note! Setting-up option 01 – 08 have the possibility of connecting a PIR sensor. The PIR sensor shifts between 2 setpoints (E42=PIR1), or between stop and normal setpoint (E42=PIR2). This may be used to e.g. save energy when a room is not occupied. PIR sensor must be connected to terminals 20 and 21.

See additional connection examples below.

Set-up 01, 05, 06, 07, 08

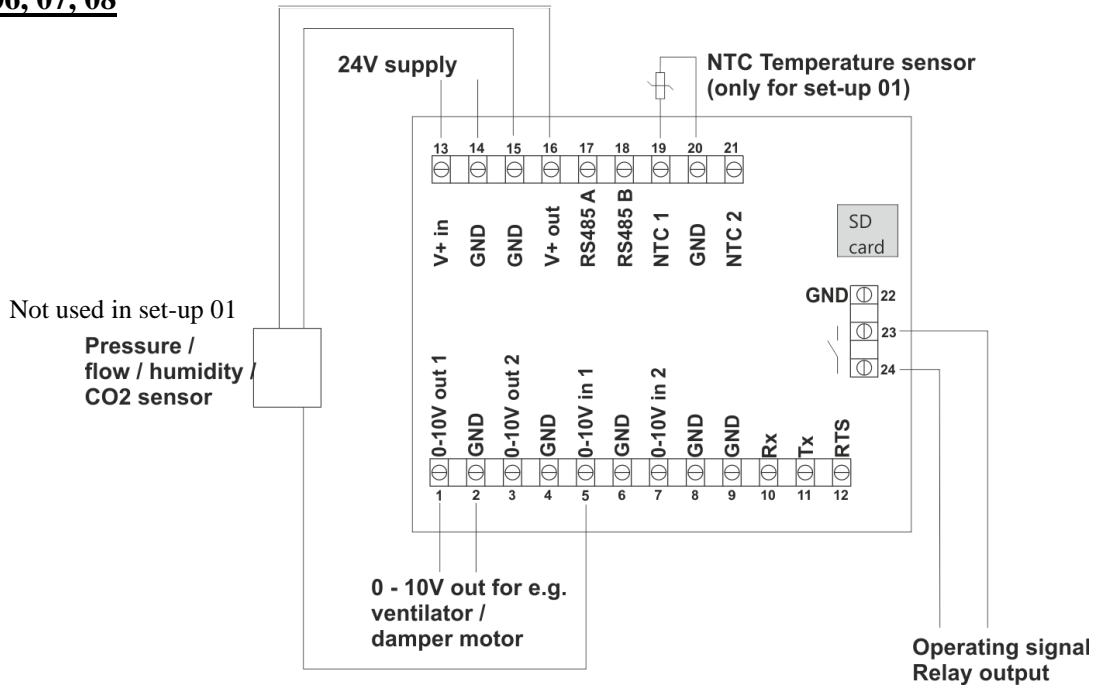

Set-up 02, 03, 04

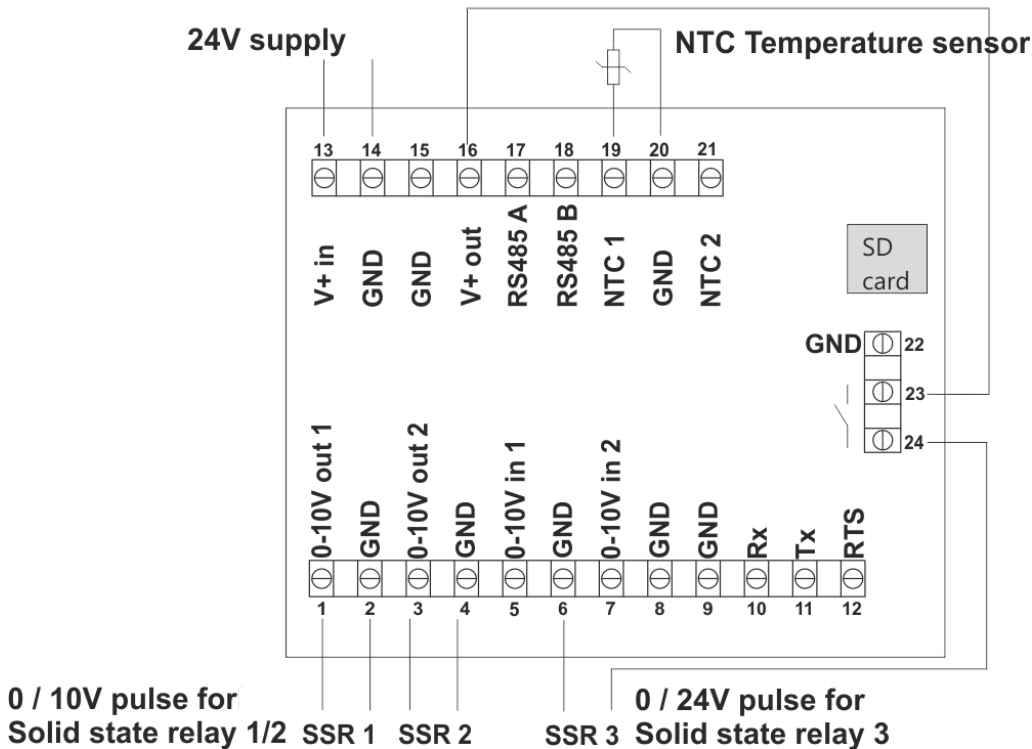

Set-up 09, 10

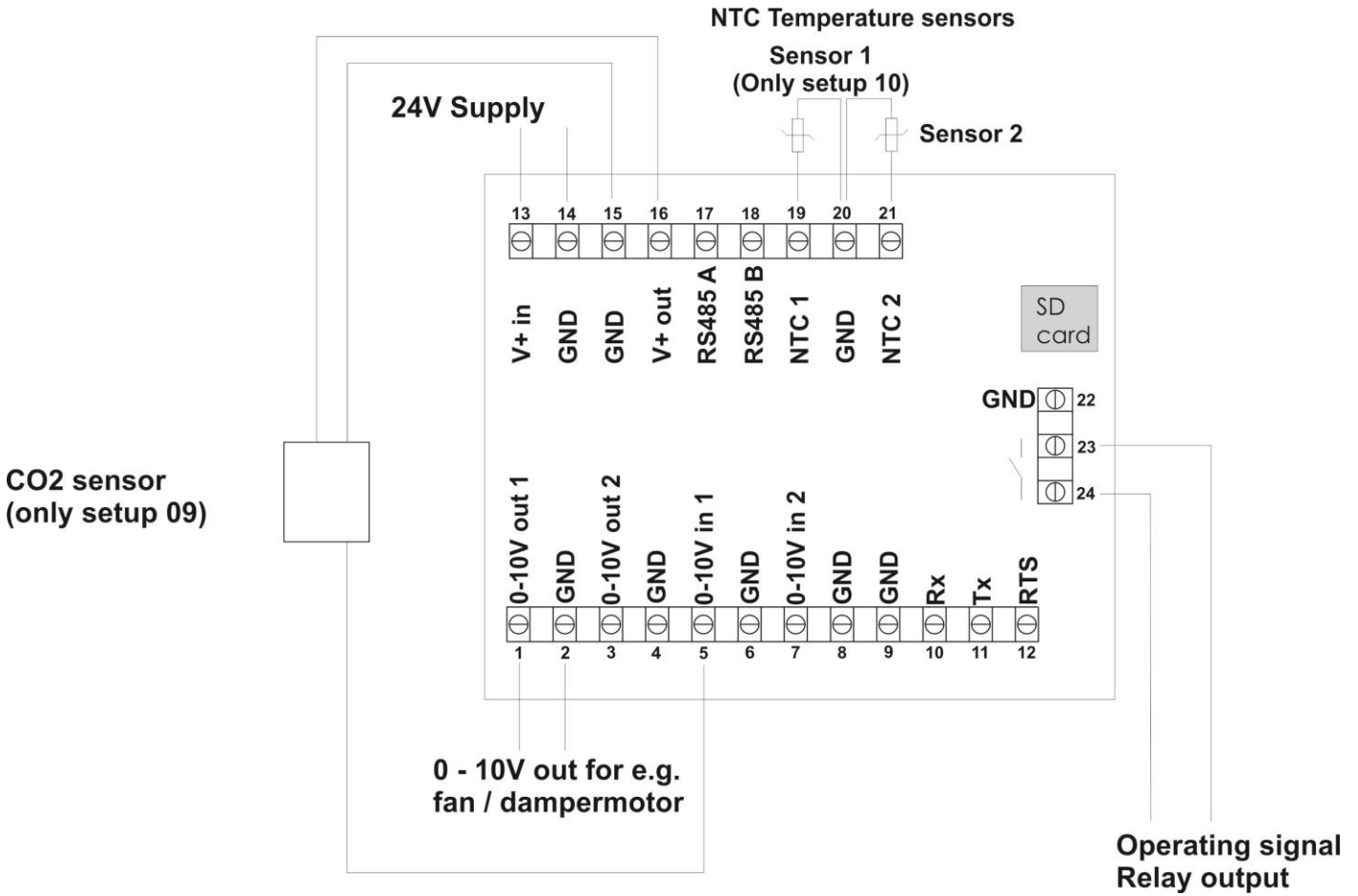

2.4 General Menu Structure

The menus in MultiController E Regulate are operated by the 4 buttons under the screen. The function of the button is visualized by an icon on each button.

The menus are built around a main menu with underlying submenus. All configuration parameters are accessed from the submenus.

The menus automatically times out if no buttons are activated for 2 minutes.

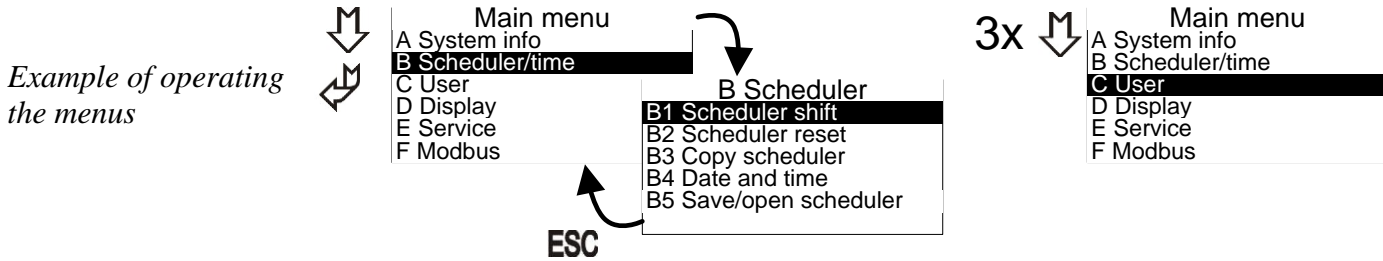

Various pop-up boxes for editing configuration parameters will appear:

Time ↓ 18 : 45

The values are changed by using the buttons 'arrow up' and arrow down'. The marker for choosing edited value is moved by pressing the 'Enter' button. When done editing the values, the values are saved by pressing the 'Enter' button. To cancel the editing without saving any changes; press the 'ESC' button.

2.5 Main Menu and Submenus

The submenus A – F are accessible from the main menu.

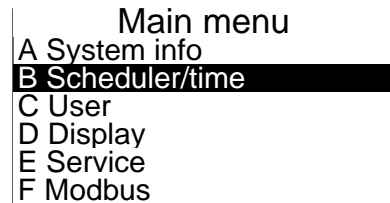

2.6 System Information (A-menu)

Submenu A displays the in- and output signals and the current operating data of the MultiController. The displayed data is updated approx. every 5 seconds.

Information		Information	
01 I-ntc	: 21.4	07 VIN1	: 32 %
02 Ntc1	: 23.4	08 VIN2	: 74 %
03 Ntc2	: -13.7	09 VOUT1	: 1 %
04 VIN1C	: 2.1	10 VOUT2	: 100%
05 VIN2C	: 8.6	11 PID1	: 10
06 REL	: ON	12 PID2	: 1000

- 01: I-NTC Internal box temperature measured with internal sensor.
- 02: NTC1 Temperature measured at NTC1 input (terminals 19+20). No sensor = - 40°C
- 03: NTC2 Temperature measured at NTC2 input (terminals 20+21). No sensor = - 40°C
- 04: VIN1C Calculated value of VIN1. (E.g. If values in menu E15 + E16 is defined as 0V= 0Pa/10V=500 Pa, then 5V at VIN1 will be displayed as 250 Pa at VIN1C)
- 05: VIN2C Calculated value of VIN2. (E.g. If values in E27 + E28 is defined as 0V= 0°C/10V=50°C, then 5V at VIN2 will be displayed as 25°C at VIN2C)
- 06: REL Display the relay position. OFF = open switch. ON= closed switch (terminals 23+24)
- 07: VIN1 Measured input signal on VIN1 input (terminals 5+6)
- 08: VIN2 Measured input signal on VIN2 input (terminals 7+8)
- 09: VOUT1 Output signal on VOUT1 (terminals 1+2)
- 10: VOUT2 Output signal on VOUT2 (terminals 3+4)
- 11: PID1 PID regulator 1
- 12: PID2 PID regulator 2

2.7 Scheduler Menu (B-menu):

The integrated scheduler function is enabled/disabled in the user menu (C-menu, menu point C2).

The integrated scheduler function consists of a week scheduler with the possibility of up to 10 shifts per day.

The scheduler function gives the option of shifting amongst normal setpoint (NOMR), alternative setpoint (ALT) or ‘Stop’ on a specific day / time every week.

An icon in the main window indicates current scheduler status.

B1:

The scheduler is programmed in menu B

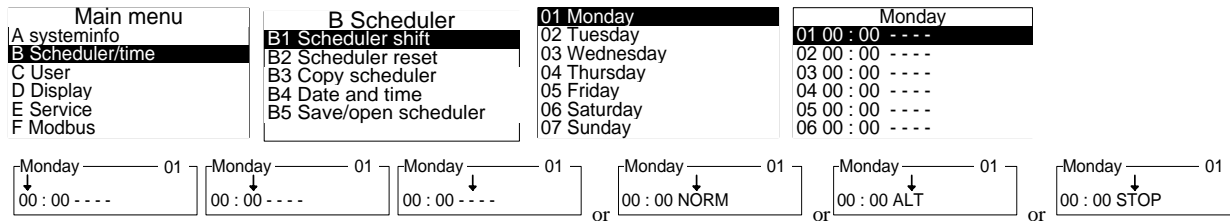

Set time and operation for one shift at a time – press “enter” ↵ after each setting.

Operation has 3 possibilities:

- Choose NORM for normal operation. Setpoint C1.
- Choose ALT for alternative setpoint. Setpoint C3.
- Choose STOP to have the regulator stopping the regulated subject (e.g. ventilator).

Repeat above for each required shift and day. (Also see point B3)

NB! A shift is only valid, if operation is different from ‘----’ i.e. if one of the 3 options above is chosen.

Please note, it is still possible to change the setpoint manually in the main window. However, at next scheduled shift the regulator will revert to the settings.

B2: Scheduler Reset.

Use this function to reset scheduler.

Note: All scheduler settings are deleted! (except date and time)

B3: Copy all scheduler settings from one day to another. Previous settings will be overwritten during copying.

B4: Date and Time.

In this menu time, date and day of the week are set.

The clock is a 24-hour clock. Automatic change between summer time and norm time is available.

Multicontroller E is equipped with battery backup for the clock. This ensures that shorter power cuts do not affect the clock. After longer power cuts (> 72 hours) the clock must be set once again.

B5: Save / Open Scheduler.

The scheduler settings may be copied to a MicroSD card by use of the ”save/open scheduler” function. First a MicroSD card (max 2GB) must be inserted in the MultiController. Then you enter the B5-menu and choose ‘save’. When the settings are saved you might retrieve the settings in another MultiController by moving the SD card to this MultiController, where the settings are retrieved by entering menu B5 and select ‘open’. The saved settings are the retrieved and scheduler settings set.

2.8 User Menu (C-menu)

User menu features some of the most common and frequently used control configurations. Following may be altered:

C1: This is where setpoint for **Regulator 1 (NORM)** is set.

This setpoint is used by the scheduler as the normal operation value (NORM). The setpoint may be altered from the main window using arrow up/down, unless double window mode (C7) is enabled, then setpoint cannot be altered in the main window. It should be noted that changes in the setpoint value performed from the main window is only valid until the next scheduled shift in scheduler or the regulator has been turned off/on.

C2: Enabling and disabling of the integrated scheduler function.

C3: This is where the alternative setpoint for **Regulator 1 (ALT)** is set.

This setpoint is used by the scheduler or PIR function when using the alternative setpoint (ALT).

C4: Security Level is set in this menu.

0 = Only service menu is password protected (**Password: 5550**)

1 = All menus are password protected.

2 = All push buttons except the 'Enter' push button is password protected.

3 = All push buttons are password protected.

C5: Prolonged Operation (number of minutes).

In this menu the number of minutes for prolonged operation is set. The function is activated from the main window by pressing the 'Enter' push button for 3 sec., then choose "ON" using the arrow buttons. When prolonged operation expires the multicontroller send a stop signal. It will either send start signal at the next scheduled shift from scheduler or by manually pressing 'Enter' button. Number of minutes at prolonged operation is displayed in the main screen (fig 1 on page 4 "J").

C6: Setpoint Source.

Choose whether setpoint is set in the MultiController or by external signal on input Vin2 (signal is defined in **E25-E28**)

C7: Value Display

Choose whether setpoint or current measured value from connected sensor or double screen is displayed in main window. If current measured value should be displayed (C7=ON), if setpoint should be displayed (C7=OFF). The measured value is either displayed as current value or an average of the last 10 measures. If the latter should be displayed choose (C7=AVG). **Note;** If measured value is chosen for display, the setpoint will be displayed for approx. 5 sec. (with SET after the number) whenever the setpoint is adjusted via the main window or at operation shift. If display is running in double window mode C7="dbl screen", both setpoints and measured value for both regulator 1 and 2 is simultaneously displayed in the main window.

C8: Alarm.

When 0 sec. is selected; alarm function is not activated. When 2-60 sec. is selected; alarm function is activated.

NOTE: If (E40=5) Night-cooling is activated, then the alarm relay function is not available.

NOTE: The operation relay function (**E5/E6**) is only available if E42 = Alarm2 is set.

Time (number of seconds) determine how long the alarm setpoint (E43) must be exceeded before alarm occurs, or for how long alarm input (NTC2+GND) must be open before alarm occurs (E42=Alarm1/2). At Flow and pressure regulation the alarm occurs when the sensor measurement is lower than the alarm setpoint. At temperature-humidity-CO₂ regulation, alarm occurs when sensor measurement is higher (exceeds) the alarm set point. Alarm is indicated by an alarm text in the display and a shift in the relay.

If E42=ALARM2, the alarm is displayed in window but relay is not affected.

C9: Optional Plant Text. This menu point is for enabling or disabling. Text is entered in **E44**

C10: Counter Counting Operation Hours: Enter number of moths before display of optional service text. (Text is entered in **E45**). Text is displayed 15 seconds each minute till counter is reset.

Reset of counter is only possible when service text is not displayed in window. To reset service text press ESC for approx. 3 seconds, then press Enter to confirm the reset.

C11: This is where the normal set point for **regulator2** (NORM) is set.

C12: This is where the alternative setpoint for **Regulator2** (ALT) is set.

This setpoint is used by the scheduler or PIR function when using the alternative setpoint (ALT).

2.9 Display Menu (D-menu)

In this menu the more general configuration options for the display is set.

D1: Version and model is displayed.

D2: Language in display. Choose the menu language amongst Danish, English, Swedish or German.

D3: Display contrast. Adjust using the up/down arrow buttons.

D4: Reset to Factory Setting.

Factory reset may affect vital configurations therefore, the MultiController prompt for approval before resetting is performed. **Note;** scheduler function is also reset when resetting to factory settings. After reset the MultiController will restart showing the quick start guide for selection of model and function.

D5: Save / retrieve set points to / from a MicroSD card (max. 2GB)

D6: Select MultiController model. Choose between '0-10V controller'(Regulate) or manual (0-100%). If 0-100% model is chosen please refer to the manual for MultiController E 0-100, which you may download from www.lscontrol.dk

2.10 Service Menu (E-menu)

The service menu contains the more advanced configurations and settings.

The menu is access protected, hence the configurations set in this menu are vital and erroneous setting may ruin the functionality of the controller.

Access code / Password: 5550

E1: Type of Regulation. (**Regulator1**)

Regulator1 is set to one of the following: Temperature (°C), Pressure (Pa), Air Flow (m/s), Humidity (%RH) or CO₂ (ppm)

E2: Direction of Output Signal. (**Regulator1**)

To invert the direction of the output signal of controller use this function.

Normal: input signal lower than set setpoint = output signal increases.

Inverted: input signal higher than set setpoint = output signal increases.

E3: Choice of Temperature Sensor Type. (Regulator1)

If the controller is set to temperature regulation, the temperature sensor type is to be set. Choose amongst NTC22K (E3=NTC22K and connect sensor to terminal 19-20), a 0-10Volt sensor (E3=2 and connect sensor to terminal 5-6), or NTC10K (E3=3 and connect sensor to terminal 19-20).

E4: Controller Output. (Regulator1)

The controller output may be set to be a 0-10V signal, a pulse output (Only if the controller is set to operate as “Temp Pulse” using the quick menu) or Compressor mode (See special manual for compressor function). The pulse output signal may be set as one PWM signal output, 2 PWM signal outputs or 2 PWM signal + relay shift. When pulse output is chosen the first PWM signal is modulated according to the pulse length (described in E19)

E5: Relay Option

The integrated change-over relay may be configured to NormallyClosed (E5=0) or NormallyOpen (E5=1).
If alarm function (C8) is activated this menu point / option is not available.

E6: Relay shifting point.

The output voltage at which the relay must shift from inactive to active must be set in this point (Vout1). **If the alarm function (C8 or E42=ALARM1) or night cool (E40=5) is activated this menu point / option is not available.** If E6=0, the relay shifts as soon as the controller is activated.

E7: Regulator Type. (Regulator1)

The integrated controller output (Vout1 on terminals 1+2) may be configured to function as a XP regulator (E7=XP) or a PI regulator (E7=PI).

E8: XP-Band (Regulator1)

If XP regulator is chosen (E7=XP) the band width (steepness) must be set in this menu point. The band represents the +- sensor deviation relative to the set point. A low value results in a significant change in the output signal (steep), a higher value results in a lesser change in the output value (less steep).

E9: XP-Volt at Setpoint (Regulator1).

If XP regulator is chosen (E7=XP). The output voltage of the setpoint must be entered in this menu point.

E10: PID Regulator – P-term. (Regulator1).

If PID regulator is chosen (E7=PI) the value for proportional amplification parameter is entered in this menu point.

E11: PID Regulator – I-term (Regulator1)

If PID regulator is chosen (E7=PI) the value for proportional attenuation parameter is entered in this menu point.

E12: PID regulator – H-term (Regulator1)

If PID regulator is chosen (E7=PI) this parameter is set to determine the sampling frequency (how often the signal should be regulated). Resolution is 100ms.

Menu E13..E16 (Regulator1)

The MultiController may be set for use of different type of sensors (see section 2.3)
 The parameters for sensor range and voltage are set in menus E13-E16.

E13: Minimum output voltage of the connected sensor (on Vin1). (Regulator1)

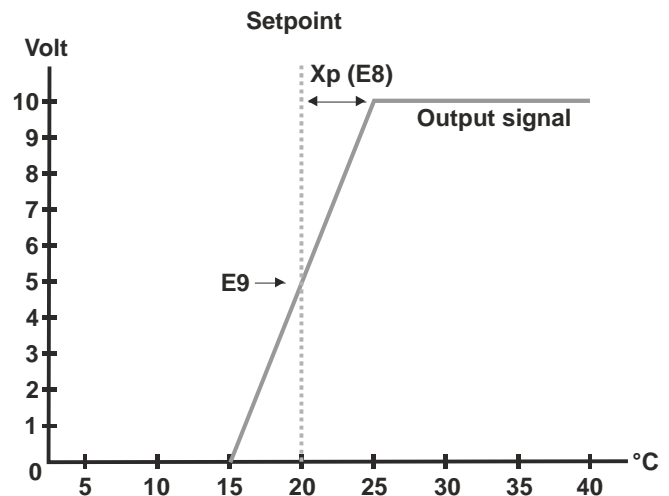

E14: Maximum output voltage of the connected sensor (on Vin1). **(Regulator1)**

E15: Sensor value at minimum. **(Regulator1)**

The value of the sensor at minimum output voltage (E13) must be entered.

E16: Sensor value at maximum. **(Regulator1)**

The value of the sensor at maximum output voltage (E14) must be entered.

E17: Minimum Output Voltage. **(Regulator1)**

If the connected equipment cannot be regulated from 0V, minimum output signal must be adjusted here.

E18: Maximum Output Voltage. **(Regulator1)**

If the connected equipment cannot be regulated to 10V, maximum output signal must be adjusted here.

E19: Period Time Setting for Pulse-regulation. **(Used only with Temp-Pulse)**

If the MultiController output is set to pulse regulation the time of pulse period of the pulse on output 1 (terminal 1 and 2) is set here.

Figure 1: Pulse output sequence

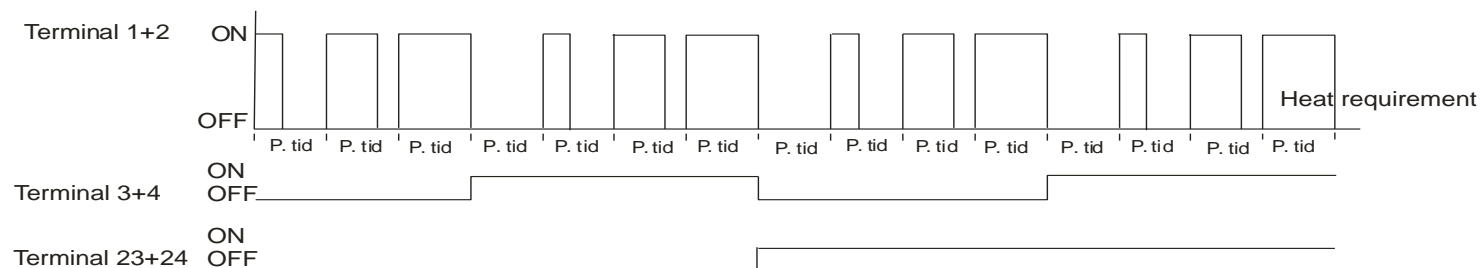

E20: Outside temperature compensation function OFF/ON. **Note:** Outside temperature compensation may be activated regardless of sensor type for regulator (see section 2.3). outside temperature is measured by a temperature sensor connected to terminal 20 and 21. If the outside temperature gets below the setpoint set in E23 the compensation of pressure/air/temperature setpoint begins. This compensation will continue until the outside temperature reach the value of setpoint E22. Maximum compensation increase/decrease is set in E21.

Note: The outside temperature compensation is only functioning for setpoint Regulator1 NORM. Compensation up/down is performed according to setpoint each 20 sec.

E21: Maximum compensation **(may be an increase or a decrease)**.

E22: Outside temperature at highest compensation.

E23: Outside temperature for start of compensation.

E24: Not in use.

E25: Minimum output voltage of the connected sensor (on Vin2). **(Regulator2)**

E26: Maximum output voltage of the connected sensor (on Vin2). **(Regulator2)**

E27: Sensor value at minimum. **(Regulator2)**

The value of the sensor at minimum output voltage (E25) must be entered.

E28: Sensor value at maximum. (Regulator2)

The value of the sensor at maximum output voltage (E26) must be entered.

E29: Regulator2 united with Regulator1.

Regulator2 is united with regulator1 (Highest signal wins) and transmitted on output Vout1.

E30: Regulator type. (Regulator2)

The integrated controller output (Vout2 on terminals 3+4) may be configured to function as a XP regulator (E30=XP) or a PI regulator (E30=PI).

E31: XP-band. (Regulator2)

If XP regulator is chosen (E30=XP) the band width (steepness) must be set in this menu point. The band represents the +/- sensor deviation relative to the set point. A low value results in a significant change in the output signal (steep), a higher value results in a lesser change in the output value (less steep).

E32: XP-volt at setpoint. (Regulator2).

XP regulator is chosen (E30=XP). The output voltage of the setpoint must be entered in this menu point.

E33: PID regulator – P-term. (Regulator2)

If PID regulator is chosen (E30=PI) the value for proportional amplification parameter is entered in this menu point.

E34: PID regulator – I-term. (Regulator2)

If PID regulator is chosen (E30=PI) the value for proportional attenuation parameter is entered in this menu point.

E35: PID regulator – H-term. (Regulator2)

If PID regulator is chosen (E30=PI) this parameter is set to determine the sampling frequency (how often the signal should be regulated). Resolution is 100ms.

E36: Minimum output voltage. (Regulator2)

If the connected equipment cannot be regulated from 0V, minimum output signal must be adjusted here.

E37: Maximum output voltage. (Regulator2)

If the connected equipment cannot be regulated to 10V, maximum output signal must be adjusted here.

E38: Direction of Output Signal. (Regulator2)

To invert the direction of the output signal of controller use this function.

Normal: input signal lower than set setpoint = output signal increases.

Inverted: input signal higher than set setpoint = output signal increases.

E39: Not in use.

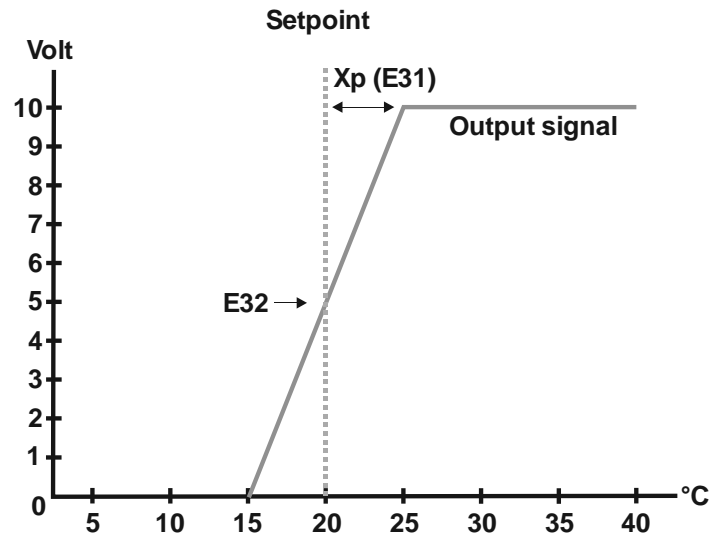

E40: Vout2 (Regulator 2)

If E40=0, then Vout2 permanently is 10V DC. If E40=1, then the output is regulated as PID/XP regulator2.

If E40=2, then the output will be an offset of Regulator1 (see **E49**). If E40=3, the output is 10V when the regulator is ON and 0V when the regulator is OFF. If E40=4, the output is 10V when value of Regulator1 exceeds the value of E2 (minimum output), when value of Regulator1 = E2 or below, the output is 0V.

If E40=5 Night cool function is enabled. If E40=6-9 the output is 0V DC. If E40=10-100 then the output is a constant factor of number set (e.g. E40=10 output is 1.0V DC, E40=55 output is 5.5V DC and if E40=100 output is 10,0V DC).

E41: Type of regulation. (Regulator2)

Regulator 2 is set to one of the following: Temperature (°C), Pressure (Pa) or CO₂ (ppm).

E42: Selection of sensor input. (Regulator2)

NTC22K= NTC22K sensor on terminal 20-21. **Volt**= 0-10V signal on terminal 7-8 (0-10V signal is defined in menu E25-E28). **Alarm1**= terminal 20-21 is used as alarm input (open signal=alarm text + relay shift). **Tacho**= terminal 20-21. **PIR1** (Shift between NORM/ALT operation) = terminal 20-21. **NTC10K**=10K ohm NTC sensor on terminal 20-21. **PIR2** (Shift between NORM/OFF operation) = terminal 20-21.

Alarm2= terminal 20-21 is used as alarm input (open signal=alarm text).

E43: Alarm setpoint

Enter the setpoint for activating alarm (Regulator1). **Note:** Alarm function must be activated in menu **C8**.

If E42= Alarm1, the relay shifts and alarm text will be displayed in window when alarm setpoint is exceeded.

If E42 = Alarm2, only an alarm text will be displayed in window when alarm setpoint is exceeded.

E44: User defined text - Name.

A plant name or similar may be entered (max. 12 characters). **Note:** Display text must be activated in menu **C9**

E45: User defined text – Operation time counter.

An alarm text or similar may be entered (max. 6 lines of 12 characters). **Note:** Operation time counter must be activated in menu **C10**

E46: Alarm level Min.

If E42=TACHO: lower limit for tacho signal must be set.

Adjustment: If tacho alarm occurs while motor is running minimum rotations, the value must be increased.

If E42=Alarm1/Alarm2: Lower limit for "open collector" signal must be set.

Adjustment: If alarm occurs while input is connected via an "open collector" the value must be increased. (If input is connected via relay switch adjustment is not required).

E47: Alarm level Max:

If E42=TACHO: Upper limit for tacho signal must be set.

Adjustment: If tacho alarm occurs while motor is running maximum rotations, the value must be increased.

E48: PIR Time.

Run time for PIR is entered in seconds.

E49: Offset of Vout2 in relation to Vout1 (Solely if E40=2). Equation: $V_{out2} = V_{out1} \times (E49/100)$

E50: K-factor Reg1.

If Regulator1 is set to function as a pressure regulator it is possible to convert the pressure to m³/h using the K-factor. This makes Regulator1 regulate in m³/h. If K-factor value is set to 0 (E50=0) the conversion function is disabled. Equation: $m^3/h = \sqrt{\Delta Pressure} \times E50 \times 3,6$

E51: K-factor Reg2.

If Regulator2 is set to function as a pressure regulator it is possible to convert the pressure to m³/h using the K-factor. This makes Regulator2 regulate in m³/h. If K-factor value is set to 0 (E51=0) the conversion function is disabled.

Equation: $m^3/h = \sqrt{\Delta Pressure} \times E51 \times 3,6$

E52: Time delay before regulation is released when starting the MultiController (Regulation output is maintained at 0V for the set time). Relay shifts without delay. **Note: E6 must be set to 0.0**

E53: Start level for Regulator1. Adjust the start level of regulator1.

E54: Start level for Regulator2. Adjust the start level of regulator2.

E59: Do not display measurement unit.

Set if measurement unit (e.g. °C) is displayed in window.

E60: Adjust clock by seconds.

Possibility of adjusting the clock by number of seconds. If the clock is either a little too fast or too slow this function will adjust the clock by number of entered seconds once a week (Monday at 13:13).

E61: Night cool room temperature.

When room temperature exceeds the setpoint, night cooling is released.

E62: Night cool difference.

Temperature difference between outside temperature and room temperature must exceed the setpoint before night cool is released. (outside temperature must always be cooler than room temperature).

E63: Night cool min.

If outside temperature is cooler than setpoint, night cool is disabled.

2.11 Modbus Menu (F-menu)

MultiController E Regulate may be configured as a Modbus slave. The Interface is serial RS-485.

Modbus communication uses the Modbus RTU standard with up to 19200Baud.

Note: The data points in the menus may be set from a Modbus master. Except for F4, hence this menu point is used to lock the configuration from being altered via Modbus.

Following menu points sets up the MultiController to work as Modbus slave.

F1: Address: Slave address is entered here.

F2: Baudrate is set to Off, 9600 and 19200. Baudrate must be set to 9600 or 19200 to activate Modbus.

F3: Parity: Parity options are; EVEN, ODD, NONE.

F4: Allow configuration from Modbus. F4=1 to enable the Modbus master to alter the configuration. F4=0 locks the MultiController from being altered by Modbus master. **Note:** This parameter cannot be changed via Modbus, but must be set manually in MultiController.

Complete MODBUS parameter list is available at www.lscontrol.com

3 Setpoint Overview

Name	Factory Setting	Min.	Max.	Unit
C1 regulator1 setpoint (NORM) Dep. on input selection E1	Temp: 22.0 Flow: 3.00 Pressure: 200 Humidity: 60 CO ₂ : 800	Temp: -20.0 Flow: 0.0 Pressure: 0 Humidity: 0 CO ₂ : 0	Temp: 65.0 Flow: 50.0 Pressure: 9999 Humidity: 100 CO ₂ : 2000	Temp: °C Flow: m/s Pressure: Pa Humidity: % CO ₂ : ppm
C2 Scheduler OnOff	OFF	OFF	ON	ON/OFF
C3 regulator1 setpoint (ALT) Dep. on input selection E1	Temp: 22.0 Flow: 2,00 Pressure:150 Humidity: 50 CO ₂ : 700	Temp: -20.0 Flow: 0.0 Pressure: 0 Humidity: 0 CO ₂ : 0	Temp: 65.0 Flow: 50.0 Pressure: 9999 Humidity: 100 CO ₂ : 2000	Temp: °C Flow: m/s Pressure: Pa Humidity: % CO ₂ : ppm
C4 User Rights	0	0	3	
C5 Prolonged Operation	10	1	240	min
C6 Setpoint Source	Internal	Internal	External	
C7 Display setpoint (=OFF). Display measured value (=ON), Display measured average (=AVG), Double window display (=dbl Screen)	OFF			OFF ON AVG Dobb. display
C8 Alarm	0	0 / 1	60	Sec.
C9 Optional text	OFF	OFF	ON	
C10 Operation time counter	0	0	12	Months
C11 regulator2 setpoint (NORM) Dep. on input selection E41	Temp: 22.0 Pressure: 200 CO ₂ : 800 Pressure: 1.00	Temp: -20.0 Pressure: 0 CO ₂ : 0 Pressure: 0.00	Temp: 65.0 Pressure: 9999 CO ₂ : 2000 Pressure: 50.00	Temp: °C Pressure: Pa CO ₂ : ppm Pressure: Bar
C12 regulator2 setpoint (ALT) Dep. on input selection E41	Temp: 22.0 Pressure: 150 CO ₂ : 700 Pressure: 0.50	Temp: -20.0 Pressure: 0 CO ₂ : 0 Pressure: 0.00	Temp: 65.0 Pressure: 9999 CO ₂ : 2000 Pressure: 50.00	Temp: °C Pressure: Pa CO ₂ : ppm Pressure: Bar
E1 Reg1 input (temp, pressure, flow, Humidity, CO ₂)				Temp: °C Pressure: Pa Flow: m/sec. Humidity: %rH CO ₂ : ppm
E2 Regulator direction	Temp: Normal Flow: Normal Pressure: Normal Humidity: Inverted CO ₂ : Inverted	Normal	Inverted	
E3 Temperature sensor1 choice (NTC1)	NTC22K			NTC22K Volt NTC10K
E4 Regulator1 output (0=0-10V 1=PWM 2=PWM+1 3=PWM+2 4=Compressor / cooling control) (1-2-3 Solely used for Temp. Pulse)	0	0	4	
E5 Relay direction (NC=0, NO=1)	NOpen	NOpen	NClosed	
E6 Relay shifting point	0.1 V	0.0 V	10.0 V	Volt
E7 Regulator1 type	PID reg.	PID reg.	XP reg.	
E8 XP band (Regulator1) Dep. on input selection E1	Temp: 2.0 Flow: 2.10 Pressure: 50 Humidity: 10 CO ₂ : 200	Temp: 0.5 Flow: 0.00 Pressure: 2 Humidity: 5 CO ₂ : 50	Temp: 25.0 Flow: 20.0 Pressure: 1000 Humidity: 40 CO ₂ : 500	Temp: °C Flow: m/s Pressure: Pa Humidity: % CO ₂ : ppm
E9 XP volt at setpoint (Regulator1)	5.0	1.0	10.0	Volt

Name	Factory Setting	Min.	Max.	Unit
E10 PID P (Regulator1)	Temp: 20 Flow: 40 Pressure: 40 Humidity: 40 CO ₂ : 40	1	100	
E11 PID I (Regulator1)	Temp: 100 Flow: 20 Pressure: 20 Humidity: 20 CO ₂ : 20	0	5000	
E12 PID reg. time (H) x 100	3	1	1000	ms
E13 Min. Input1	0.0	0.0	10.0	Volt
E14 Max.Input1	10.0	0.0	10.0	Volt
E15 Sensor1 Value at Min. Dep. on input selection E1	Temp: 0.0 Flow: 0 Pressure: 0 Humidity: 0 CO ₂ : 0	Temp: -40.0 Flow: 0.00 Pressure: 0 Humidity: 0 CO ₂ : 0	Temp: 60.0 Flow: 50.00 Pressure: 5000 Humidity: 100 CO ₂ : 5000	Temp: °C Flow: m/s Pressure: Pa Humidity: % CO ₂ : ppm
E16 Sensor Value at Max. Dep. on input selection E1	Temp: 50.0 Flow: 8.0 Pressure: 500 Humidity: 100 CO ₂ : 2000	Temp: -40.0 Flow: 0.00 Pressure: 0 Humidity: 0 CO ₂ : 0	Temp: 60.0 Flow: 50.00 Pressure: 9999 Humidity: 100 CO ₂ : 5000	Temp: °C Flow: m/s Pressure: Pa Humidity: % CO ₂ : ppm
E17 Min.output1	0.0	0.0	5.0	V
E18 Max.output1	10.0	5.0	10.0	V
E19 Pulse Time Periods (s) (Solely used with Temp Pulse)	Temp Pulse:30	10	250	Sec.
E20 OutTempOnOff (NTC2)	OFF	OFF	ON	ON/OFF
E21 Outside Temperature Reduction Dep. on input selection E1	Flow: 0.0 Pressure: 0 Temp: -5.0	Flow: -5.00 Pressure: -500 Temp: -10.0	Flow: 5.00 Pressure: 500 Temp: 10.0	m/s Pa °C
E22 Outside Temperature min. temp.	-10 °C	0,0 °C	-25 °C	°C
E23 Outside Temperature max. temp.	10,5 °C	-10 °C	15 °C	°C
E24 Not in use				
E25 Min. input 2	0.0	0.0	10.0	Volt
E26 Max. input 2	10.0	0.0	10.0	Volt
E27 Sensor2 Value at Min.	Temp: 0.0 Pressure: 0.0 CO ₂ :0.0 Pressure 0.00	-40.0 0.0 0.0 0.00	60.0 5000 5000 50.0	°C Pa Ppm Bar
E28 Sensor2 Value at Max.	Temp: 50.0 Pressure: 500 CO ₂ :2000 Pressure: 8.00	-40.0 0.0 0.0 0.00	60.0 9999 5000 8.00	°C Pa Ppm Bar
E29 Reg2 united with Reg1	OFF	OFF	ON	
E30 Reg2 Selection	PID Reg.	PID Reg.	XP Reg.	
E31 Reg2 XP amplification	10	1	9999	Temp: °C Pressure: Pa CO ₂ : ppm
E32 Reg2 XP Volt out at setpoint	5.0	0.1	10.0	Volt
E33 Reg2 PID P	20	1	100	
E34 Reg2 PID I	200	0	5000	
E35 Reg2 PID Reg Time (H) @100ms	1	1	1000	ms
E36 Min. Output2	0.0	0.0	5.0	V
E37 Max. Output2	10.0	5.0	10.0	V
E38 Reg2 Direction	Normal	Normal	Inverted	

Name	Factory Setting	Min.	Max.	Unit
E39 Not in use				
E40 Vout2 (0=10V, 1=Regulator, 2=offset, 3=Mode, 4=regulator1, 5=Night Cool (6-9=0V, 10-100=1,0-10,0V))	0	0	100	
E41 Reg2 input (temp, pressure, CO ₂)	°C			Temp: °C Pressure: Pa Pressure: Bar CO ₂ : ppm
E42 TempSensor2 selection. NTC22K =NTC2, Volt =Vin2, Alarm1 = NTC2, Tacho =KI 20-21, PIR1 = KI 20-21, NTC10K =NTC2, PIR2 = KI 20-21, Alarm2 = NTC2	NTC22K			NTC22K Volt Alarm1 Tacho PIR1 NTC10K PIR2 Alarm2
E43 Alarm Setpoint (Alarm1)	Temp: 5.0 Flow: 1.00 Pressure: 100 Humidity: 20 CO ₂ : 1200	Temp: -20 Flow: 0.00 Pressure: 0 Humidity: 0 CO ₂ : 0	Temp: 79 Flow: 99.99 Pressure: 9999 Humidity: 110 CO ₂ : 9999	Temp: °C Flow: m/s Pressure: Pa Humidity: % CO ₂ : ppm
E44 User Defined Text; Name				
E45 User Defined Text; Hour Counter				
E46 Alarm Level Min	10	0	50	
E47 Alarm level Max	60	50	100	
E48 PIR Time	10	1	36000	Sec.
E49 Offset of Vout2	100	1	200	%
E50 K-factor Reg 1	0.00	0	99.99	0 (0=Disabled)
E51 K-factor Reg 2	0	0	99.99	0 (0=Disabled)
E52 Time Delay Regulator Start	0	0	240	Sec.
E53 Start level Reg1	500	0	1000	
E54 Start level Reg2	500	0	1000	
E59 Hide Unit	Off	Off	On	
E60 Adjust Clock	0	-100	100	Sec.
E61 Night Cool Room Temperature	21,0	16,0	28,0	°C
E62 Night Cool Difference	2.0	0,0	5,0	°C
E63 Night Cool Minimum	4,0	-10,0	21,0	°C
Name	Factory Setting	Min	Max	Unit
F1 ModbusAddress (1-247)	50	1	247	Address
F2 Modbus baudrate(0=Off 1=9600 2=19200)	0	0	2	Velocity
F3 Modbus Parity (1=EVEN 2=ODD 3=NONE)	1	1	3	Data
F4 ModbusAllowWrite	OFF	OFF	ON	OFF/ON

4 Technical Data

	24V version	230V version
Power Supply	15-30VDC or 24VAC +-15%	230V AC ±10%
Mains	Max 1A	13A
Power Consumption	Max 2,4W	Max <1W
Enclosure	IP 40 / IP 54	IP 40 / IP 54
Dimensions (HxWxD)	LSBOX85: 34x87x87 mm LSBOX85: 42x87x87 mm DIN rail: 45x85x120 mm Panel:100x100x65 mm (hul:91x91 mm) IP 54 box: 120x122x56 mm	
Operating Temperature	0 - 60 °C	0 - 50 °C
Relay	24VDC NO, 3A AC1.	5A-AC1, 250VAC NO, 150W / 1150VA.
NTC1 input	NTC temperature sensor (10K/22K)	
NTC2 input	NTC temperature sensor (10K/22K NTC) / Alarm / PIR / Relay	
0-10VDC input1 (Vin1)	7k Ohm input impedance	
0-10VDC input2 (Vin2)	7k Ohm input impedance	
0-10VDC output1 (Vout1)	0-10,0V DC Max 10mA	
0-10VDC output2 (Vout2)	0-10,0V DC Max 10mA	
RS-485	Channel A and B	
SD card reader	MicroSD, max. 2 Gb	
Jumper	120 Ohms termination RS-485	

5 Applied Standards

EN 61000-6-1 and EN 61000-6-3 Electromagnetic Compatibility (EMC)
 EN-60335-1 The Low Voltage Directive

This product complies with the RoHS, Directive 2011/65/EU.
 Drawing: 950-206726 MultiControllerE-regulate_ES874_26_UK
 Date: 05-12-2018
 Rev.: 2.8

Software Version: Program 2.6

Drawn by: UP/TJ/MJ

Manufactured by: LS Control A/S Industrivej 12, DK 4160 Herlufmagle.

www.lscontrol.dk - tel. +45 5550 5550

LSCONTROL

